

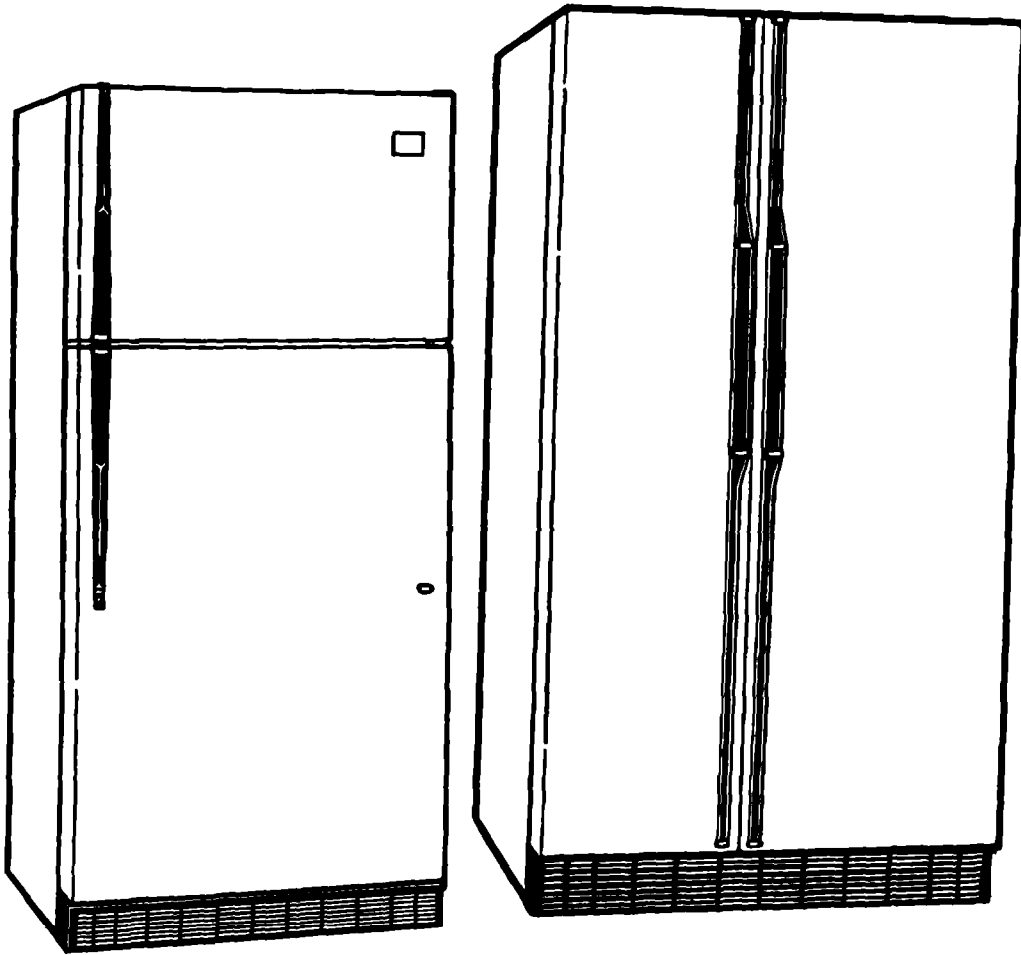

NO-FROST REFRIGERATOR-FREEZER



Use And Care Guide

12/94

B

Table of Contents

	Page		Page
A Note to You	2	Adjusting the crisper humidity control	15
Important Safety Instructions	3	Adjusting the crisper cover track	15
Parts and Features	4	Adjusting the freezer shelf	16
Before Using Your Refrigerator	6	Adjusting the half-width freezer shelf	16
Using Your Refrigerator	8	Removing the pull-out freezer floor	17
Setting the controls	8	Using the ice cube trays	17
Changing the control settings	9	Using the optional automatic ice maker	18
Removing the drop-in door trim pieces	9	Removing the base grille	19
Removing the snap-off door trim	10	Changing the light bulbs	19
Removing the snap-off door trivets	10	Understanding the sounds you may hear	20
Adjusting the door bins	10	Saving energy	21
Adjusting the utility compartment and tray	11	Reversing the door swing	21
Adjusting the refrigerator shelves	11	Caring for Your Refrigerator	22
Adjusting the EZ-Track™ refrigerator shelf	12	Food Storage Guide	25
Removing the meat drawer and cover	13	Troubleshooting	27
Removing the crispers and crisper cover	14	Requesting Service	27
		Warranty	28

A Note to You

Thank you for buying a Whirlpool® appliance.

Because your life is getting busier and more complicated, Whirlpool Refrigerators are easy to use, save time, and help you manage your home better. To ensure you enjoy years of trouble-free operation, we developed this Use and Care Guide. It contains valuable information about how to operate and maintain your appliance properly and safely. Please read it carefully.

Your safety is important to us.

This guide contains statements under warning symbol. Please pay special attention to this symbol and follow any instructions given. Here is a brief explanation of the use of the warning symbol.

WARNING

This symbol will help alert you to such dangers as personal injury, burns, fire, and electrical shock.

Please record your model's information.

Whenever you call to request service on your appliance, you need to know your complete model number and serial number. You can find this information on the model and serial number label (see diagram on pages 4-5 for location of label).

Please also record the purchase date of your appliance and your dealer's name, address, and telephone number.

Model Number _____

Serial Number _____

Purchase Date _____

Dealer Name _____

Dealer Phone _____

Keep this book and the sales slip together in a safe place for future reference.

Important Safety Instructions

⚠ WARNING

To reduce the risk of fire, electrical shock, or injury when using your refrigerator, follow these basic precautions:

- Read all instructions before using the refrigerator.
- Child entrapment and suffocation are not problems of the past. Junked or abandoned refrigerators are still dangerous ... even if they will "just sit in the garage a few days."

If you are getting rid of your old refrigerator, do it safely. Please read the enclosed safety booklet from the Association of Home Appliance Manufacturers. Help prevent accidents.

- Never allow children to operate, play with, or crawl inside the refrigerator.
- Never clean refrigerator parts with flammable fluids. The fumes can create a fire hazard or explosion.

• FOR YOUR SAFETY •

DO NOT STORE OR USE GASOLINE OR OTHER FLAMMABLE VAPORS AND LIQUIDS IN THE VICINITY OF THIS OR ANY OTHER APPLIANCE. THE FUMES CAN CREATE A FIRE HAZARD OR EXPLOSION.

- SAVE THESE INSTRUCTIONS -

Help us help you

Please:

- Install and level the refrigerator on a floor that will hold the weight and in an area suitable for its size and use.
- Do not install the refrigerator near an oven, radiator, or other heat source.
- Do not use the refrigerator in an area where the room temperature will fall below 13°C (55°F).
- Keep the refrigerator out of the weather.
- Connect the refrigerator only to the proper kind of outlet, with the correct electrical supply and grounding.
- Do not load the refrigerator with food before it has time to get properly cold.
- Use the refrigerator only for the uses described in this manual.
- Properly maintain the refrigerator.
- Be sure the refrigerator is not used by anyone unable to operate it properly.

Parts and Features

This section contains captioned illustrations of your appliance. Use them to become familiar with where all parts and features are located and what they look like.

Control panels

STYLE 1

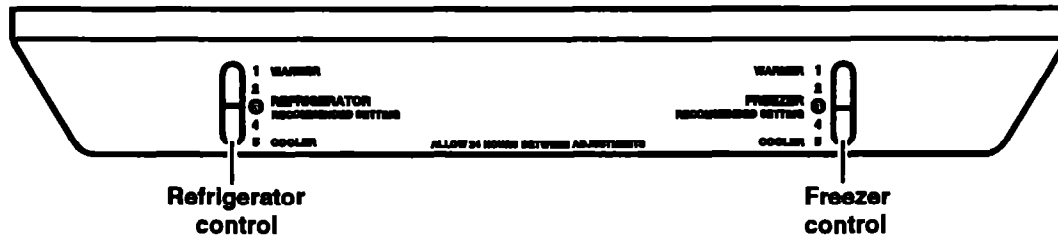

STYLE 2

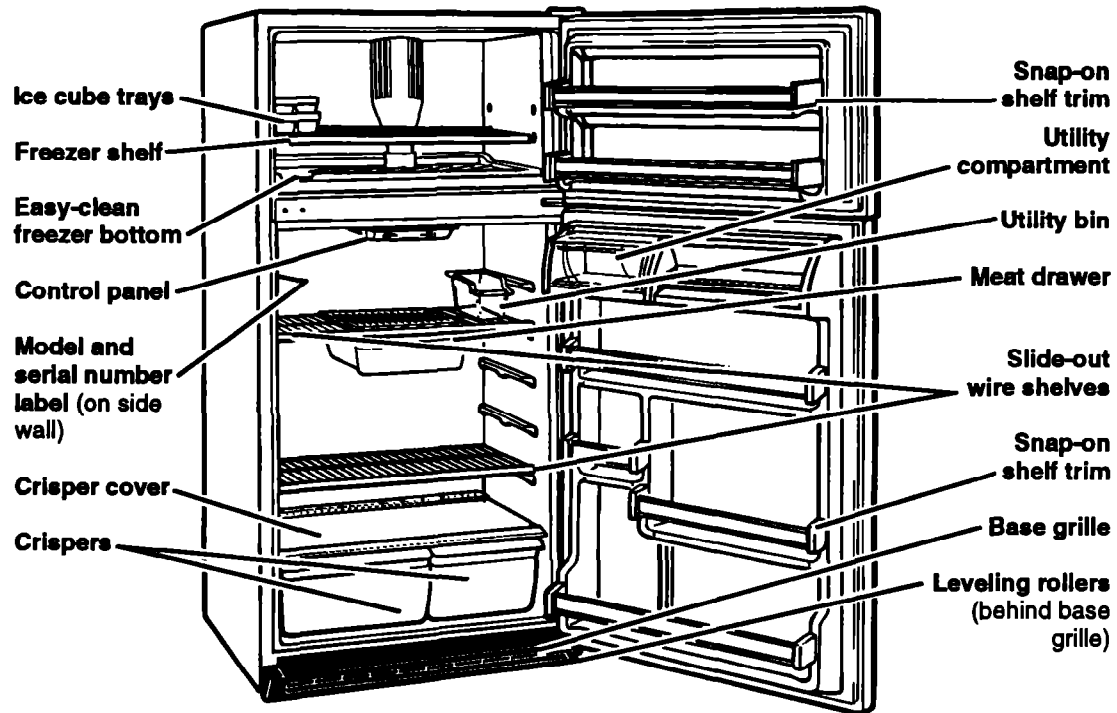
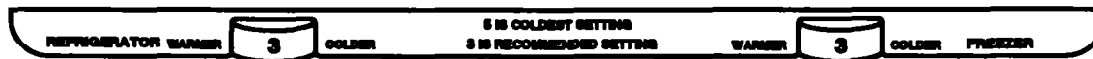

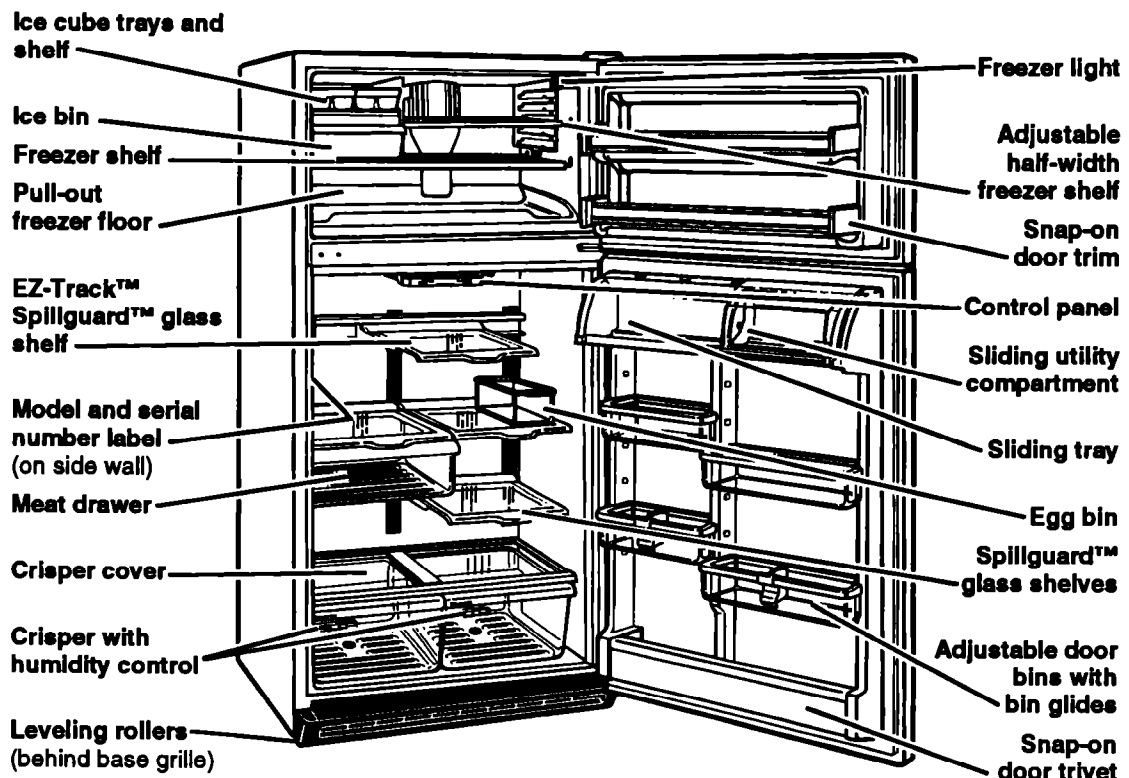
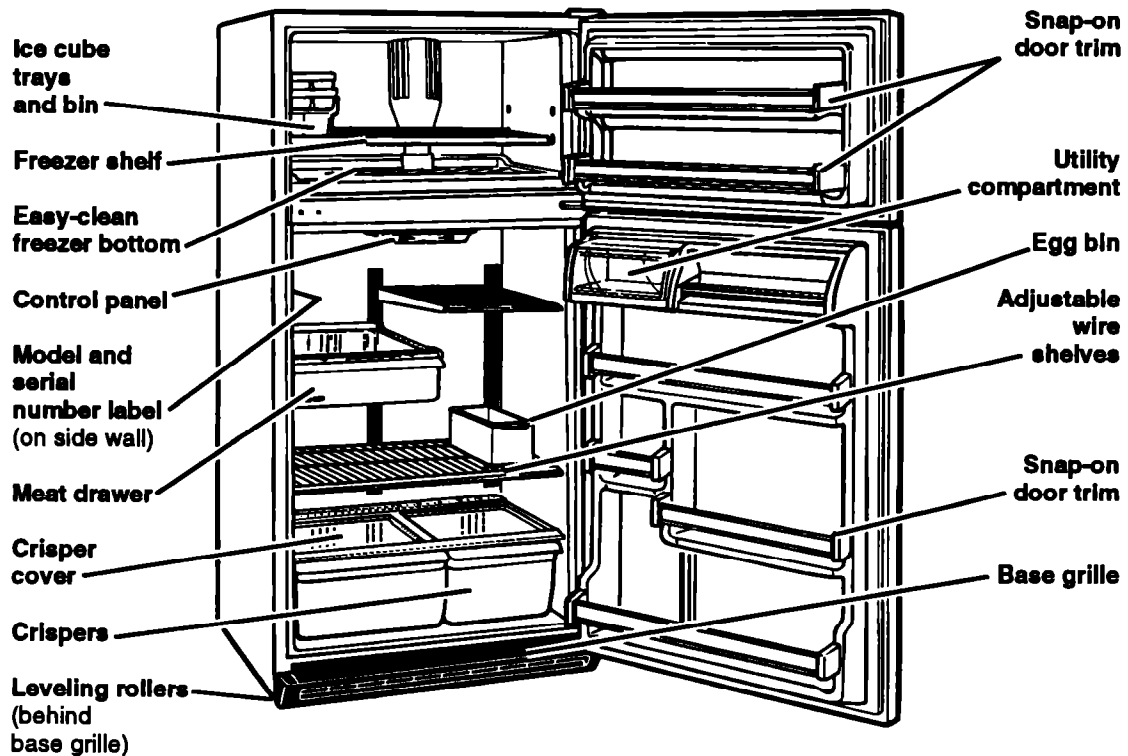

Before Using Your Refrigerator

It is important to prepare your refrigerator for use. This section tells you how to clean it, connect it to a power source, install it, and level it.

Cleaning your refrigerator

Removing packaging materials

Remove tape and any inside labels (except the model and serial number label) before using the refrigerator.

To remove any remaining glue:

- Rub briskly with thumb to make a ball, then remove.

OR

- Soak area with liquid hand-dishwashing detergent before removing glue as described above. Do not use sharp instruments, rubbing alcohol, flammable fluids, or abrasive cleaners. These can damage the material. See "Important Safety Instructions" on page 3.

NOTE: Do not remove any permanent instruction labels inside your refrigerator. Do not remove the Tech Sheet fastened under the refrigerator at the front.

Cleaning it before use

After removing all packaging materials, clean your refrigerator before using it, if necessary. See cleaning instructions on pages 22-23.

Plugging it in

Recommended Grounding Method

A 115 Volt/60 Hz (Plug 1), 220/240 Volt/50 Hz (Plug 2), or 220 Volt/60 Hz (Plug 3) AC only 15 or 20 ampere fused and properly grounded electrical supply is required. It is recommended that a separate circuit serving only this appliance be provided. Use a receptacle which cannot be turned off with a switch or pull chain. Do not use an extension cord.

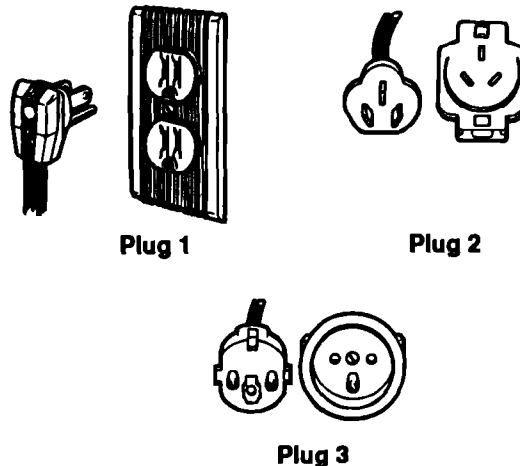

Installing it properly

1. Allow 1.25 cm (½ inch) space on each side and at the top of the refrigerator for ease of installation.
2. If the hinge side of the refrigerator is to be against a wall, you might want to leave extra space so the door can be opened wider.
3. The refrigerator can be flush against the back wall.

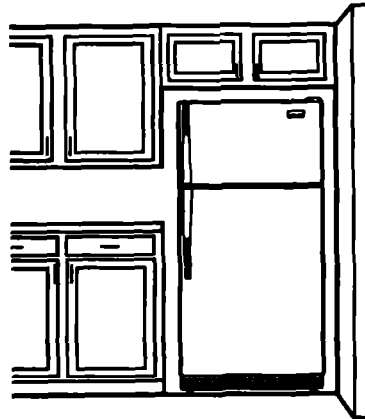

Leveling it

Your refrigerator has 2 front leveling screws – one on the right and one on the left. To adjust one or both of these, follow the directions below.

1. Remove base grille. (See page 19.)
2. To raise front, turn screw clockwise.
3. To lower front, turn screw counterclockwise.
4. Check with level.
5. Replace base grille. (See page 19.)

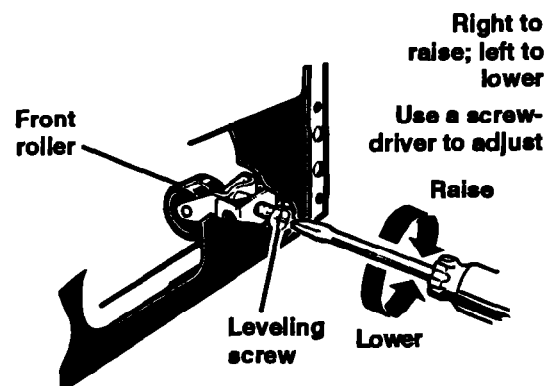

Using Your Refrigerator

To obtain the best possible results from your refrigerator, it is important that you operate it properly. This section tells you how to set the controls, remove and adjust the features in your refrigerator, and how to save energy.

Setting the controls

Controls for the refrigerator and freezer are in the refrigerator. When you plug in the refrigerator for the first time:

1. **Set the Refrigerator Control to 3 (Recommended Setting).** Refrigerator Control settings range from 1 (warmest) to 5 (coldest).
2. **Set the Freezer Control to 3 (Recommended Setting).** Freezer Control settings range from 1 (warmest) to 5 (coldest).
3. Give the refrigerator time to cool down completely before adding food. This may take several hours.

The settings indicated above should be correct for normal, household refrigerator usage. The controls are set correctly when milk or juice is as cold as you like and when ice cream is firm. If you need to adjust these settings, see "Changing the control settings" on page 9.

STYLE 1

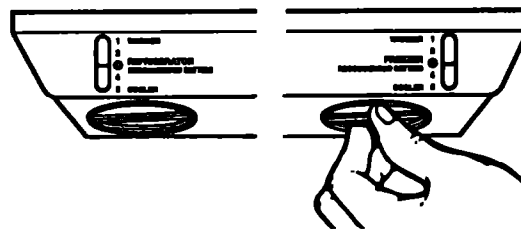

STYLE 2



Changing the control settings

If you need to adjust temperatures in refrigerator or freezer, use the settings listed in the chart below as a guide.

- Adjust the Refrigerator Control first.
- Wait at least 24 hours between adjustments.
- Then adjust the Freezer Control if needed.

CONDITION:	REASON:	RECOMMENDED CONTROL SETTINGS:	
		Refrigerator	Freezer
Refrigerator section too warm	<ul style="list-style-type: none"> • Door opened often • Large amount of food added • Room temperature too warm 	4	2
Freezer section too warm	<ul style="list-style-type: none"> • Door opened often • Large amount of food added • Very cold room temperature (can't cycle often enough) 	3	4
Refrigerator section too cold	<ul style="list-style-type: none"> • Controls not set correctly for your conditions 	2	4
Ice not made fast enough	<ul style="list-style-type: none"> • Heavy ice usage • Very cold room temperature (can't cycle often enough) 	4	4
Both sections too warm	<ul style="list-style-type: none"> • Door opened often • Large amount of food added • Very warm or very cold room temperatures 	4	4

Removing the drop-in door trim pieces

(on some models)

To remove the trim piece:

1. Remove all items from the shelf.
2. Pull straight up on the trim piece at each end.



To replace the trim piece:

1. Locate each end of the trim piece above the trim pocket opening.
2. Push the trim piece straight down until it stops.
3. Replace items on the shelf.



Removing the snap-off door trim

To remove the trim piece:

1. Remove all items from the shelf.
2. Pull out on the inside tab at each end of the trim piece.
3. Lift trim piece straight out.

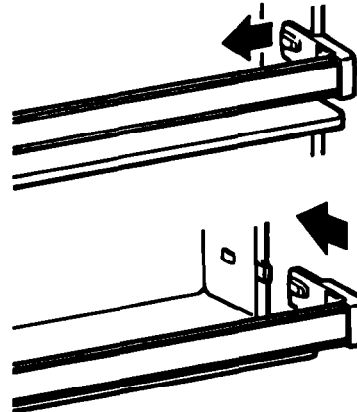

To replace the trim piece:

1. Line up ends of the trim piece with the button on the door liner wall.
2. Push trim piece straight back until it snaps securely into place.
3. Replace items on the shelf.

Removing the snap-off door trivets (on some models)

To remove the trivet:

1. Remove all items from the shelf.
2. Pull out on the inside tab at each end of the trivet.
3. Lift trivet straight out.

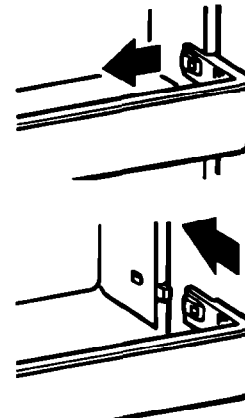

To replace the trivet:

1. Line up ends of trivet with the button on the door liner wall.
2. Push trivet straight back until it snaps securely into place.
3. Replace items on the shelf.

Adjusting the door bins (on some models)

To remove door bins:

1. Lift bin up.
2. Pull bin straight out.

To replace door bins:

1. Slide bin in above desired support button.
2. Push down until it stops.

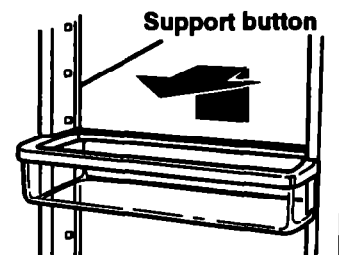

Adjusting the utility compartment and tray (on some models)

The utility compartment and tray slide from one side to the other for more flexible storage. The tray fits on either side of the utility compartment or partially underneath it. Experiment and find the positions that work best for you.

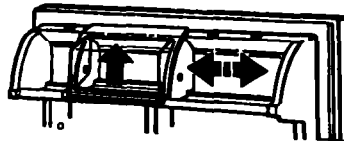

To adjust the utility compartment or tray:

1. Lift the front slightly.
2. Slide to desired position.
3. Lower front to lock into place.

Adjusting the refrigerator shelves

Adjust the shelves to match the way you use your refrigerator. Glass shelves are strong enough to hold bottles, milk, and other heavy food items.

Cantilever shelves

To remove a shelf:

1. Remove items from shelf.
2. Tilt shelf up at front.
3. Lift shelf at back.
4. Pull shelf straight out.

To replace a shelf:

1. Guide the rear shelf hooks into the slots in the shelf supports on the back liner wall.
2. Tilt front of shelf up until hooks drop into slots.
3. Lower front of shelf to a level position.

Slide-out shelves

To remove the shelves:

1. Remove all items from the shelf.
2. Slide shelf straight out to the stop.
3. Lift the front slightly.
4. Slide shelf out the rest of the way.

To replace the shelves:

1. Fit back of shelf on top of guide with wire stops on the bottom of the guide.
2. Lift the front.
3. Slide shelf in until it clears all stops.

STYLE 1

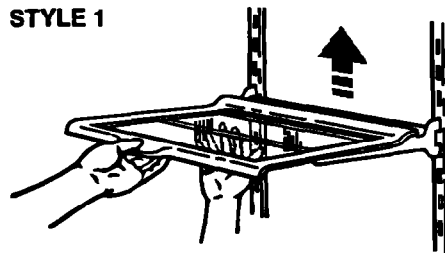

NOTE: Glass shelves are heavy. Handle them carefully.

STYLE 2

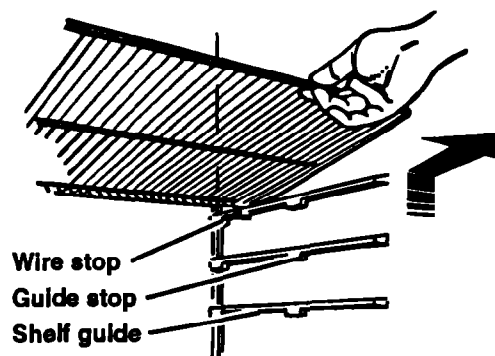

Adjusting the EZ-Track™ refrigerator shelf

(on some models)

The EZ-Track shelf slide from side to side for more flexible storage in your refrigerator.

To slide shelf side-to-side:

1. Lift slightly on shelf front.
2. Slide to desired location.
3. Lower shelf front to level position.

NOTE: You do not have to remove small items from the shelf before moving it side-to-side. You may need to remove larger items.

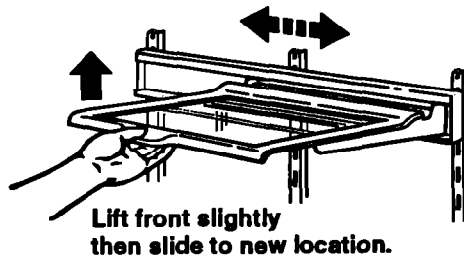

To remove the shelf:

1. Remove all items from the shelf.
2. Hold back of shelf with one hand.
3. Lift front of shelf to 45° angle.
4. Lower shelf slightly to release shelf from upper channel of track. Then pull shelf straight out.

NOTE: Shelf is heavy. Make sure you use both hands when removing shelf.

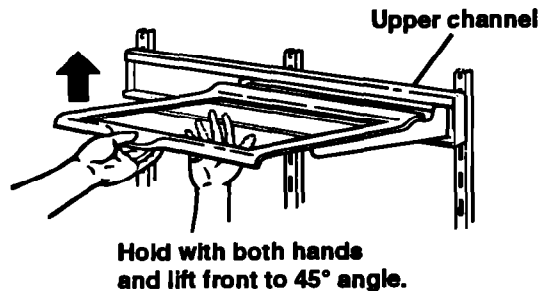

To remove shelf track:

1. Lift both sides of track slightly.
2. Pull track straight out.

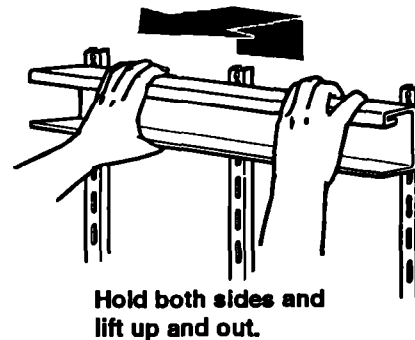

To replace shelf track:

1. Guide track hooks into the shelf support slots on the back wall of the cabinet.

NOTE: Make sure all three track hooks are in slots and that the slots are parallel to each other.

2. Push track backward and down.
3. Check that track is completely seated in the shelf supports.

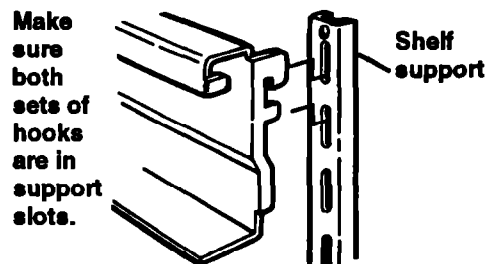

To reinstall shelf:

1. Hold shelf at front and back.
2. Tilt front of shelf up to a 45° angle to track.
3. Insert both rear shelf slides into upper channel of track.
4. Lower front of shelf to a level position.

NOTE: Make sure both rear shelf slides are securely in the track before letting go of shelf.

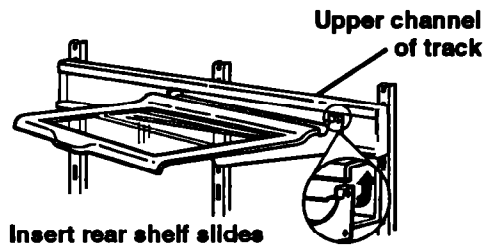

Insert rear shelf slides into upper channel of track.

Removing the meat drawer and cover

Style 1

To remove the meat drawer:

1. Slide meat drawer out to the stop.
2. Lift front of meat drawer and slide meat drawer out the rest of the way.
3. Replace in reverse order.

To adjust the cover position:

1. Tilt front of cover up.
2. Lift back of cover.
3. Pull cover straight out.

To replace the cover:

1. Guide the cover's rear hooks into the slots in the shelf supports on cabinet wall.
2. Tilt cover up at front until the hooks drop into slots.
3. Lower front of cover to a level position.

STYLE 1

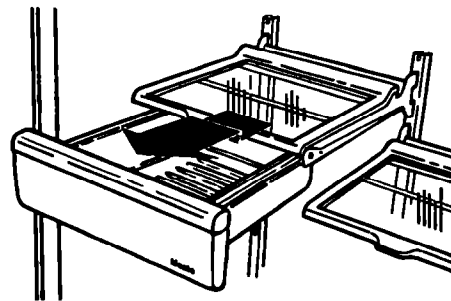

Pull out to the stop, lift the front, and pull again.

Style 2

Remove the meat drawer and cover for easier cleaning.

To remove the meat drawer:

1. Slide meat drawer out to the stop.
2. Lift the front of the meat drawer.
3. Slide meat drawer out the rest of the way.
4. Replace in reverse order.

To remove the cover:

1. Remove meat drawer.
2. Push cover back to release the rear of the cover from the shelf.
3. Tilt cover up at the front.
4. Pull cover forward and out.

To replace the cover:

1. Fit notches and rear edge of cover over rear and center crossbars on the shelf.
2. Lower cover into place.
3. Replace the meat drawer.

STYLE 2

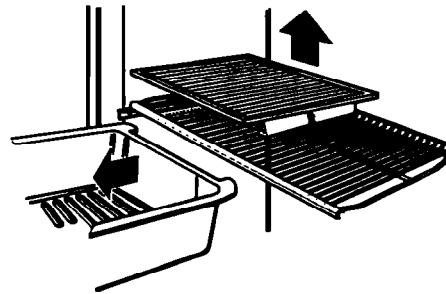

Remove meat drawer before cover.

Removing the crispers and crisper cover

For your convenience, one crisper is slightly larger than the other. This allows you to store celery and other longer items in your crisper.

To remove the crispers:

1. Slide crisper straight out to the stop.
2. Lift the front.
3. Slide out the rest of the way.
4. Replace in reverse order.

To remove the cover:

1. Push up the cover insert from the bottom, then slide out with both hands.
2. Lift front of cover frame.
3. Lift cover frame up and out.

To replace the cover:

1. Fit back of cover frame into notch supports on back wall of refrigerator, then lower the front into place.
2. Slide back of cover insert into place, then lower the front.

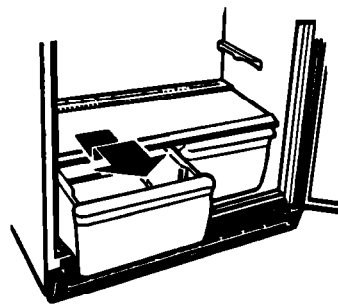

Pull out to the stop, lift the front, and pull again.

Remove the cover insert. Lift the cover front, then the back.

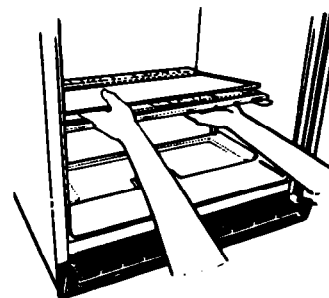

NOTE: If cover insert is glass, handle it with care. It could be heavy.

Adjusting the crisper humidity control

You can control the amount of humidity in the moisture-sealed crispers. Adjust the control to any setting between LOW and HIGH.

- LOW (open) lets moist air out of the crisper for best storage of fruits and vegetables with skins.
- HIGH (closed) keeps moist air in the crisper for best storage of fresh, leafy vegetables.



Adjusting the crisper cover track

Because your crispers are not the same size, your crisper cover has an adjustable center track so you can switch positions of the crispers. You can adjust the center track with the cover in the refrigerator by removing the crispers and the cover insert.

To remove the center track:

1. Push up the cover insert from the bottom, then slide out with both hands.
2. Gently pull up on front end of track.
3. Pull rear end of track out of opening in cover.

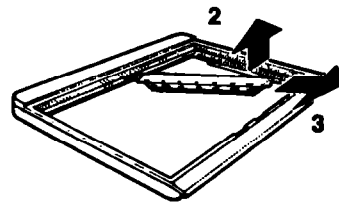

To replace the center track:

1. Insert rear end of track (with hole) into opening in cover.
2. Lower front end of track into slot.
3. Make sure rear end of track has snapped into place on under side of cover.

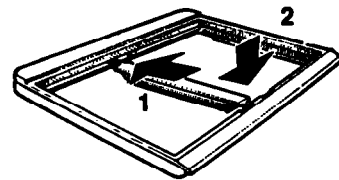

Adjusting the freezer shelf

Adjust the freezer shelf to match the way you use your freezer.

To remove the shelf:

1. Lift entire shelf slightly.
2. Move shelf all the way to one side.
3. Tilt other side up and out of shelf support cups.
4. Pull shelf up and out.

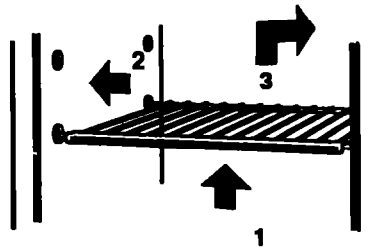

To replace the shelf:

1. Tilt the shelf and insert into freezer compartment.
2. Insert one end of the shelf all the way into the center of the shelf support cups.
3. Lower other end of shelf and insert into the shelf support cups.
4. Lower shelf into place.

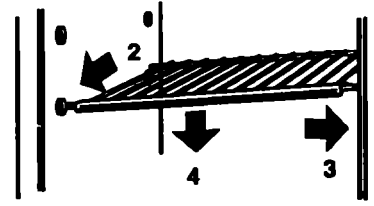

NOTE: The shelf should lower slightly and lock into place. If the shelf does not appear sturdy, make sure both ends of the shelf are inserted into the shelf support cups.

Adjusting the half-width freezer shelf

(on some models)

Adjust the shelf according to the space you need in your freezer. Use the bottom position when you don't need the shelf at all.

To adjust the shelf:

1. Remove items from the shelf.
2. Lift shelf up at front.
3. Pull shelf out to the stop.
4. Lift back of shelf.
5. Pull shelf out the rest of the way.

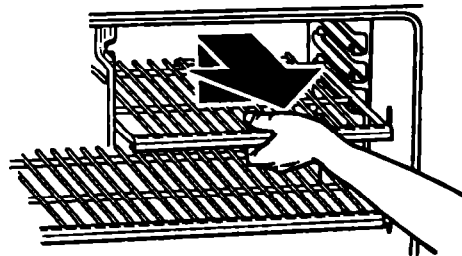

To replace the shelf:

1. Guide rear of shelf into desired guide.
2. Lift rear of shelf over stop.
3. Slide shelf in all the way.
4. Lower front into place.

Removing the pull-out freezer floor

(on some models)

The freezer floor pulls out for easier access to foods in the back of the freezer and for easier cleaning.

To remove the freezer floor:

1. Lift both back "fences" up and out.
2. Pull floor out about 1 inch (2.5 cm) with one hand around the air tower section (center back) and one hand at center front.
3. Lift floor up at rear until hooks release from cabinet.
4. Pull floor out the rest of the way.

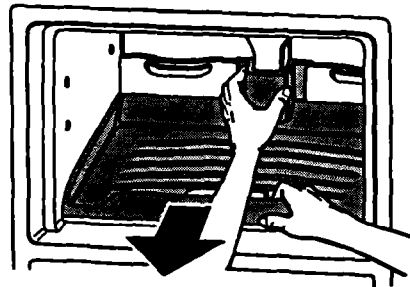

To replace the freezer floor:

1. Position back of floor into freezer opening.
2. Slide floor straight in until hooks drop into place at rear of cabinet.
3. Replace "fences" by aligning pins with sockets in the floor. Push down until they snap into place.

Using the ice cube trays

If cubes are not used, they may shrink. The moving cold air starts a slow evaporation. The longer you store cubes, the smaller they get.

To remove ice:

1. Hold tray at both ends.
2. Twist slightly.

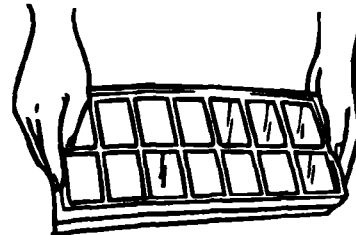

Using the optional automatic ice maker

If your refrigerator has an automatic ice maker, or if you plan to add one later (contact the dealer for ice maker kit number), here are a few things you should know.

- The ON/OFF lever is a wire signal arm.
DOWN to make ice automatically
UP to shut off the ice maker
IMPORTANT: Do not turn ice maker on until you connect it to the water supply.
- If you remove the ice bin, raise the signal arm to shut off the ice maker. When you replace the bin, push it in all the way and lower the ice maker signal arm to the ON position.
- Good water quality is important for good ice quality. Try to avoid connecting the ice maker to a softened water supply. Water softener chemicals (such as salt from a malfunctioning softener) can damage the ice maker mold and lead to poor ice quality. If you cannot avoid a softened water supply, make sure the water softener is operating properly and is well maintained.

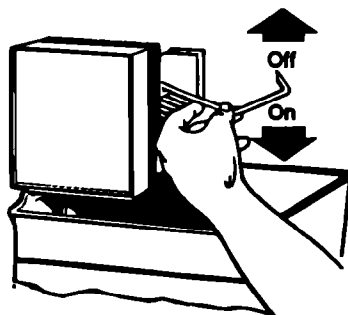

UP
to stop
ice maker.

DOWN
to start
ice maker.

Solving common ice maker problems

PROBLEM	POSSIBLE CAUSE/SOLUTION
Ice crescents attached at corners	<ul style="list-style-type: none"> • This is normal. They break apart easily. Shake bin occasionally to keep cubes separated.
Ice maker will not operate or ice is not made fast enough	<ul style="list-style-type: none"> • ON/OFF lever is in the OFF (up) position. Lower lever to the ON (down) position. • Freezer is not cold enough. Adjust temperature controls and wait 24 hours. (See "Changing the control settings" on page 9.)
Off-taste or odor in ice	<ul style="list-style-type: none"> • New plumbing connections can cause discolored or off-flavored ice. Discard the first few batches of ice. • Cubes are stored too long. Throw them away and make a new supply. • Food is not wrapped properly. See page 25. • Freezer and ice bin need to be cleaned. See page 22.

Removing the base grille

To remove the base grille:

1. Open the refrigerator door.
2. Grasp the grille with both hands.
3. Push down on the top edge of the grille to release the top clips.
4. Roll grille toward you to release top clips.
5. Pull grille away from the refrigerator.

NOTE: Do not remove the Tech Sheet fastened behind the grille.

To replace the base grille:

1. Line up the edges of the grille with the outside edges of the cabinet.
2. Roll the grille toward you.
3. Place the lower clips in the openings in the metal panel.
4. Roll the grille toward the cabinet until the top clips snap into place.
5. Close the refrigerator door.

See cleaning instructions for defrost pan and condenser coils on page 23.

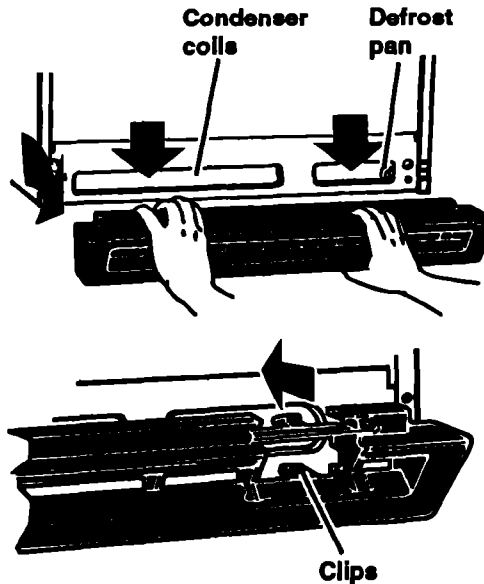

Changing the light bulbs

⚠ WARNING

Electrical Shock Hazard

Before removing a light bulb or removing a light shield for cleaning, either unplug the refrigerator or disconnect the electricity leading to it at the main power supply.

Failure to do so could result in electrical shock.

To change refrigerator light:

1. Disconnect refrigerator from power supply.
2. Reach behind Control Panel to remove bulb.
3. Replace with a 40-watt appliance bulb.
4. Reconnect refrigerator to power supply.

STYLE 1

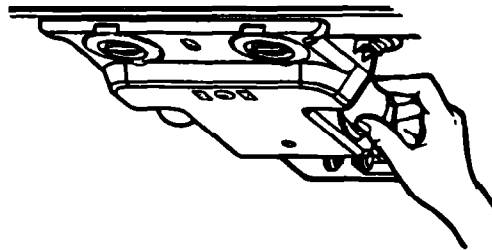

STYLE 2

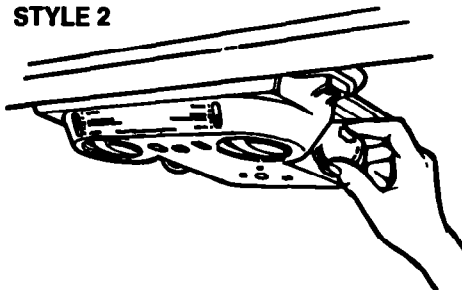

To change freezer light:

1. Disconnect refrigerator from power supply.
2. Reach behind light shield to bulb.
3. Replace bulb with a 40-watt appliance bulb.
4. Reconnect refrigerator to power supply.

NOTE: Not all appliance bulbs will fit your refrigerator. Be sure to replace a bulb with one of the same size and shape.

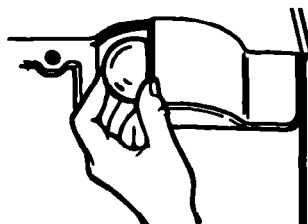

Understanding the sounds you may hear

Your new refrigerator may make sounds that your old one didn't. Because the sounds are new to you, you might be concerned about them. Don't be. Most of the new sounds are normal. Hard surfaces like the floor, walls, and cabinets can make the sounds seem louder.

The following describes the kinds of sounds that might be new to you, and what may be making them.

Slight hum, soft hiss

You may hear the refrigerator's fan motor and moving air.

Clicking or snapping sounds

The thermostat makes a definite click when the refrigerator stops running. It also makes a sound when the refrigerator starts. The defrost timer will click when the defrost cycle starts.

Water sounds

When the refrigerator stops running, you may hear gurgling in the tubing for a few minutes after it stops. You may also hear defrost water running into the defrost water pan.

Ice maker sounds

- trickling water
- thud (clatter of ice)

You may hear buzzing (from the water valve), trickling water, and the clatter of ice dumped into the bin.

Running sounds

Your refrigerator has a high-efficiency compressor and motor. It will run longer than older designs. It may even seem to run most of the time.

Saving energy

You can help your refrigerator use less electricity.

- Check door gaskets for a tight seal. Level the cabinet to be sure of a good seal.
- Clean the condenser coils regularly.
- Open the door as few times as possible. Think about what you need before you open the door. Get everything out at one time. Keep food organized so you won't have to search for what you want. Close door as soon as food is removed.
- Go ahead and fill up the refrigerator, but don't overcrowd it so air movement is blocked.
- It is a waste of electricity to set the refrigerator and freezer to temperatures colder than they need to be. If ice cream is firm in the freezer and drinks are as cold as your family likes them, that's cold enough.
- Make sure your refrigerator is not next to a heat source such as a range, water heater, furnace, radiator, or in direct sunlight.

Reversing the door swing

The doors on your refrigerator are reversible. If you need to reverse the door swing, refer to the instruction sheet included with your refrigerator.

Caring for Your Refrigerator

Your refrigerator is built to give you many years of dependable service. However, there are a few things you can do to help extend its product life. This section tells you how to clean your refrigerator and what to do when going on holiday, moving, or during a power outage.

Cleaning your refrigerator

Both the refrigerator and freezer sections defrost automatically. However, clean both about once a month to prevent odors from building up. Wipe up spills right away.

To clean your refrigerator, unplug it, take out all removable parts, and clean the refrigerator according to the following directions.

WARNING

Personal Injury Hazard

Refrigeration system tubes are near the defrost pan and can become hot. Remove and install defrost pan carefully. Failure to do so could result in personal injury.

PART	WHAT TO USE	HOW TO CLEAN
Removable parts (shelves, crisper, etc.)	Sponge or cloth with mild detergent and warm water	<ul style="list-style-type: none"> • Hand wash, rinse, and dry thoroughly.
Outside	Sponge, cloth, or paper towel with mild detergent, warm water, and an appliance wax (or good auto paste wax)	<ul style="list-style-type: none"> • Wash outside of cabinet. Do not use abrasive or harsh cleaners. • Rinse and dry thoroughly. • Wax painted metal surfaces at least twice a year. Apply wax with a clean, soft cloth. Waxing painted metal surfaces provides rust protection. • Do not wax plastic parts.
Inside walls (allow freezer to warm up so cloth won't stick)	Sponge, soft cloth, or paper towel with baking soda or mild detergent and warm water	<ul style="list-style-type: none"> • Wash with mixture of warm water and <ul style="list-style-type: none"> –mild detergent, or –baking soda (26 g [2 tablespoons] to .95 L [1 quart] of water). • Rinse and dry thoroughly.

PART	WHAT TO USE	HOW TO CLEAN
Door liners and gaskets	Sponge, soft cloth, or paper towel with mild detergent and warm water	<ul style="list-style-type: none"> • Wash, rinse, and dry thoroughly. DO NOT USE cleaning waxes, concentrated detergents, bleaches, or cleaners containing petroleum on plastic parts.
Plastic parts (covers and panels)	Soft, clean sponge or soft, clean cloth with mild detergent and warm water	<ul style="list-style-type: none"> • Wash, rinse, and dry thoroughly. DO NOT USE paper towels, window sprays, scouring cleansers, or flammable fluids. These can scratch or damage material. See "Important Safety Instructions" on page 3.
Defrost pan	Sponge or cloth with mild detergent and warm water	<ul style="list-style-type: none"> • Remove base grille. (See page 19.) • Reach into small opening at right edge and remove the defrost pan. • Wash, rinse, and dry thoroughly. • Replace defrost pan. Make sure to push it completely into the opening. • Replace base grille.
Condenser coils	Vacuum cleaner with extended narrow attachment	<ul style="list-style-type: none"> • Remove base grille. • Vacuum coils when dusty or dirty. Coils may need to be cleaned as often as every other month. • Replace base grille.
Floor under refrigerator	Floor cleaners	<ul style="list-style-type: none"> • Roll refrigerator out only as far as the water supply line allows. • Clean floor. • Roll refrigerator back into place. • Check to see if the refrigerator is level.

Holiday and moving care

Short holidays

No need to shut off the refrigerator if you will be away for less than four weeks.

1. Use up any perishables.
2. Freeze other items.

Long holidays

If you will be gone a month or more:

1. Remove all food from the refrigerator.
2. If your refrigerator has an automatic ice maker:
 - Turn off the water supply to the ice maker at least one day ahead of time.
 - When the last load of ice drops, turn off the ice maker. Make sure all ice is dispensed out of the ice maker mechanism.
3. Unplug the refrigerator.
4. Clean it, rinse well, and dry.
5. Tape rubber or wood blocks to the tops of both doors to prop them open far enough for air to get in. This stops odor and mold from building up.

⚠ WARNING

Personal Injury Hazard

Do not allow children to climb on, play near or climb inside the refrigerator when the doors are blocked open. They may become injured or trapped.

To restart refrigerator, see "Using Your Refrigerator" on page 8.

Power interruptions

If electricity goes off, call the power company. Ask how long power will be off.

1. If service will be interrupted 24 hours or less, **keep both doors closed**. This helps foods stay frozen.
2. If service will be interrupted longer than 24 hours:
 - (a) Remove all frozen food and store in a frozen food locker.

OR

- (b) Place 32 grams of dry ice in freezer for every cubic liter (2 lbs. for every cubic foot) of freezer space. This will keep food frozen for 2 to 4 days. Wear gloves to protect your hands from dry ice burns.

Moving

When you are moving the refrigerator to a new home:

1. If your refrigerator has an automatic ice maker:
 - Turn off the water supply to the ice maker at least one day ahead of time.
 - Disconnect the water line.
 - After the last load of ice drops, lift the signal arm to the OFF (up) position.
2. Remove all food from the refrigerator.
3. Pack all frozen food in dry ice.
4. Unplug the refrigerator.
5. Clean it thoroughly. Rinse well and dry.
6. Take out all removable parts, wrap them well, and tape them together so they don't shift and rattle.
7. Screw in the leveling rollers.
8. Tape the doors shut and tape the power supply cord to the cabinet.

When you get to your new home, put everything back and refer to page 5. Also, remember to reconnect the water supply line.

OR

- (c) If neither a food locker or dry ice is available, use or can perishable food at once.
3. A full freezer stays cold longer than a partly filled one. A freezer full of meat stays cold longer than a freezer full of baked goods. If food contains ice crystals, it may be safely refrozen, although the quality and flavor may be affected. If the condition of the food is poor, or if you feel it is unsafe, dispose of it.

Food Storage Guide

There is a correct way to package and store refrigerated or frozen food. To keep food fresher, longer, take the time to study these recommended steps.

Storing fresh food

Wrap or store food in the refrigerator in airtight and moisture-proof material. This prevents food odor and taste transfer throughout the refrigerator. For dated products, check code date to ensure freshness.

Leafy vegetables

Remove store wrapping and trim or tear off bruised and discolored areas. Wash in cold water and drain. Place in plastic bag or plastic container and store in crisper.

Vegetables with skins (carrots, peppers)

Store in crisper, plastic bags, or plastic container.

Fruit

Wash, let dry, and store in refrigerator in plastic bags or crisper. Do not wash or hull berries until they are ready to use. Sort and keep berries in their original container in a crisper, or store in a loosely closed paper bag on a refrigerator shelf.

Eggs

Store without washing in the original carton on interior shelf.

Milk

Wipe milk cartons. For best storage, place milk on interior shelf.

Butter or margarine

Keep opened butter in covered dish or closed compartment. When storing an extra supply, wrap in freezer packaging and freeze.

Cheese

Store in the original wrapping until you are ready to use it. Once opened, rewrap tightly in plastic wrap or aluminum foil.

Leftovers

Cover leftovers with plastic wrap or aluminum foil. Plastic containers with tight lids can also be used.

Meat

Store most meat in original wrapping as long as it is airtight and moisture-proof. Rewrap if necessary. See the following chart for storage times.

TYPE	APPROXIMATE TIME (DAYS) [†]
Chicken	1 to 2
Ground beef	1 to 2
Steaks and roasts	3 to 5
Cured meats	7 to 10
Bacon	5 to 7
Cold cuts	3 to 5
Variety meats	1 to 2

[†] When storing meat longer than the times given, follow the directions for freezing.

NOTE: Use fresh fish and shellfish the same day as purchased.

Storing frozen food

The freezer section is designed for storage of commercially frozen food and for freezing food at home.

NOTE: For further information about preparing food for freezing or food storage times, check a freezer guide or reliable cookbook.

Packaging

The secret of successful freezing is in the packaging. The way you close and seal the package must not allow air or moisture in or out. Packaging done in any other way could cause food odor and taste transfer throughout the refrigerator and drying of frozen food.

Packaging recommended for use:

- Rigid plastic containers with tight-fitting lids
- Straight-sided canning/freezing jars
- Heavy-duty aluminum foil
- Plastic-coated paper
- Non-permeable plastic wraps (made from a saran film)

Follow package or container instructions for proper freezing methods.

Do not use:

- Bread wrappers
- Non-polyethylene plastic containers
- Containers without tight lids
- Waxed paper
- Wax-coated freezer wrap
- Thin, semi-permeable wrap

The use of these wrappings could cause food odor, taste transfer, and drying of frozen food.

Freezing

Do not expect your freezer to quick-freeze any large quantity of food. Put no more unfrozen food into the freezer than will freeze within 24 hours (no more than 32 to 48 grams of food per liter [2 to 3 lbs. per cubic foot] of freezer space). Leave enough space for air to circulate around packages. Be careful to leave enough room at the front so the door can close tightly.

Storage times will vary according to the quality of the food, the type of packaging or wrap used (airtight and moisture-proof), and the storage temperature, which should be -17.8°C (0°F).

Troubleshooting

Listed in this chart are the most common problems consumers run into with their appliances. Please read through this and see if it can solve your problem.

PROBLEM	CHECK THE FOLLOWING
Your refrigerator will not operate	Is the power supply cord firmly plugged into a live circuit with proper voltage? Has a household fuse or circuit breaker blown/tripped? Is the Refrigerator Control set to the OFF position?
The lights do not work	Is the power supply cord firmly plugged into a live circuit with proper voltage? Has a household fuse or circuit breaker blown/tripped? Is a bulb burned out?
You hear unfamiliar sounds or a rattling/jingling noise	Is something on top of or behind the refrigerator? Some new sounds are normal. See "Understanding the sounds you may hear" on page 20.
There is water in the defrost pan	This is normal on hot, muggy days. Make sure the refrigerator is level so the pan does not overflow.
The motor seems to run too much	Are the condenser coils dirty? Has the door been open often? Has a large amount of food been added at one time? The motor naturally runs longer in these cases. Is the room hot? If the room is too warm, the motor runs longer to keep the unit cool.

Requesting Service

1. If the problem is not due to one of the items listed in Troubleshooting ...

Contact the dealer from whom you purchased the unit or an authorized Whirlpool® service company.

***When asking for help or service:**

Please provide a detailed description of the problem, your appliance's complete model and serial numbers, and the purchase date. (See page 2.) This information will help us respond properly to your request.

2. If you need FSP* replacement parts* ...

FSP is a registered trademark of Whirlpool Corporation for quality parts. Look for this symbol of quality whenever you need a replacement part for your Whirlpool appliance. FSP replacement parts will fit right and work right because they are made to the same exacting specifications used to build every new Whirlpool appliance.

To locate FSP replacement parts in your area, contact the dealer from whom you purchased the unit or an authorized Whirlpool service company.

WHIRLPOOL^{*}

Refrigerator Warranty

LENGTH OF WARRANTY	WHIRLPOOL WILL PAY FOR						
FULL ONE-YEAR WARRANTY From Date of Purchase	FSP* replacement parts and repair labor to correct defects in materials or workmanship. Service must be provided by an authorized Whirlpool service company.						
FULL FIVE-YEAR WARRANTY From Date of Purchase	FSP replacement parts and repair labor to correct defects in materials or workmanship in the sealed refrigeration system. These parts are: <table style="width: 100%; border: none;"> <tr> <td style="width: 50%;">1. Compressor</td> <td style="width: 50%;">4. Drier</td> </tr> <tr> <td>2. Evaporator</td> <td>5. Connecting tubing</td> </tr> <tr> <td>3. Condenser</td> <td></td> </tr> </table> Service must be provided by an authorized Whirlpool service company.	1. Compressor	4. Drier	2. Evaporator	5. Connecting tubing	3. Condenser	
1. Compressor	4. Drier						
2. Evaporator	5. Connecting tubing						
3. Condenser							

WHIRLPOOL WILL NOT PAY FOR

- A. Service calls to:**
 - 1. Correct the installation of your refrigerator.
 - 2. Instruct you how to use your refrigerator.
 - 3. Replace house fuses or correct house wiring or plumbing.
 - 4. Replace light bulbs.
- B. Repairs when your refrigerator is used in other than normal, single-family household use.**
- C. Pickup and delivery. Your refrigerator is designed to be repaired in the home.**
- D. Damage to your refrigerator caused by accident, misuse, fire, flood, acts of God, or use of products not approved by Whirlpool.**
- E. Any food loss due to product failure.**
- F. Repairs to parts or systems caused by unauthorized modifications made to the appliance.**

5/93

WHIRLPOOL CORPORATION SHALL NOT BE LIABLE FOR INCIDENTAL OR CONSEQUENTIAL DAMAGES.

Outside the United States, a different warranty may apply. For details, please contact your authorized Whirlpool distributor or military exchange.